



**The *specialists* for
marine fendering**

Woodrolfe Road · Tollesbury
Essex · CM9 8RY · England
Tel: +44 (0)1621 869609
Fax: +44 (0)1621 868863
Email: sales@wilks.co.uk
www.wilks.co.uk

FLEXITEEK



The *specialists* for marine fendering

Wilks is proud to be one of the world's leading companies in the manufacture and supply of impact protection and decking systems.

Since 1973 we have supplied many leading boat builders with their profiles and our customer base spans the globe.

We manufacture a wide range of fendering profiles for both boat and pontoon applications as well as accessories for other marine users including Flexiteek, the original synthetic teak decking for boats.

At our premises we hold a vast stock of profiles in flexible PVC, rigid PVC, stainless steel, aluminium and rubber; but as manufacturers we can also supply to meet your individual trade requirements.





BUMP!

Real Protection with Style



Great looking fendering that's quick and easy to fit with no front fastenings!

Available in a black, white or traditional wood effect finish.

BUMP! 65

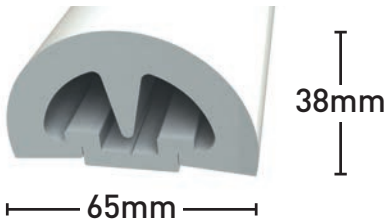

BUMP! 53

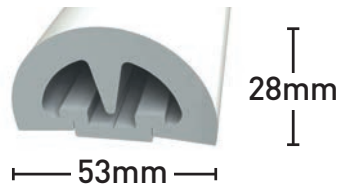

For details of our complete range please visit www.wilks.co.uk

Pontoon Fendering

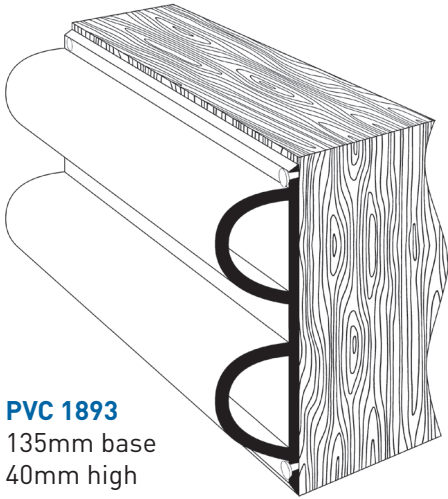

PVC 1893
135mm base
40mm high

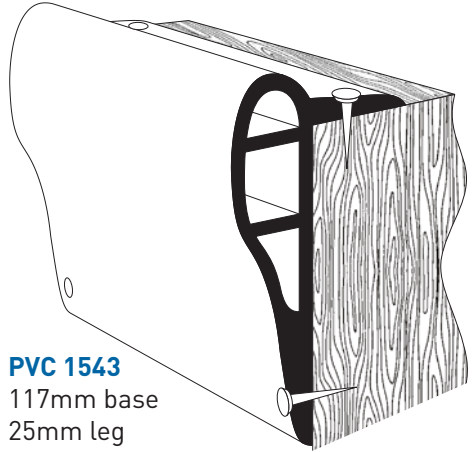

PVC 1543
117mm base
25mm leg

D Profiles

A wide range of heavy duty profiles are available at www.wilks.co.uk

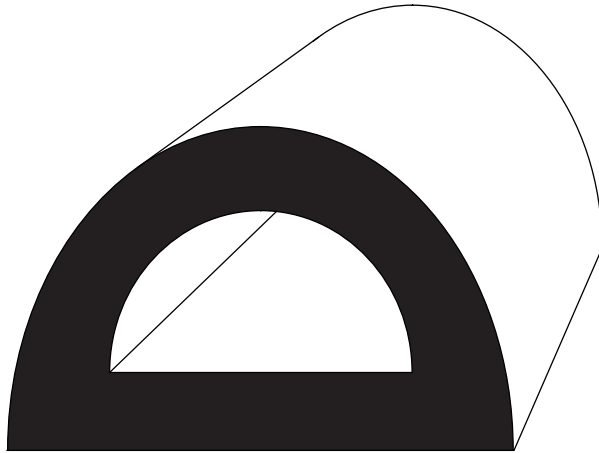

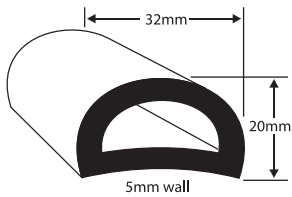

PVC 50

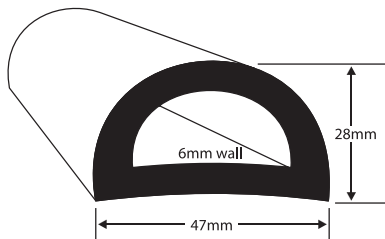

PVC 49

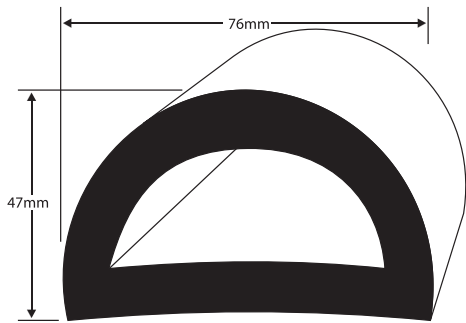

PVC 898

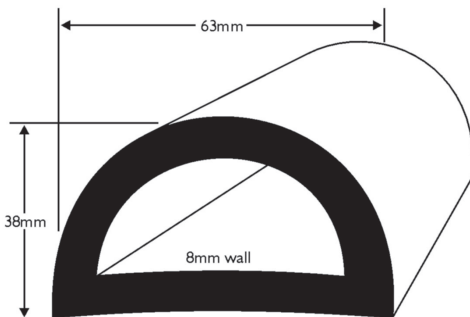

PVC 632

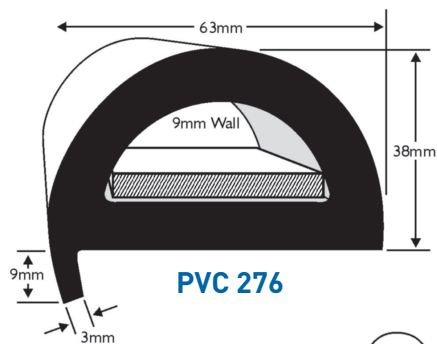

PVC 276

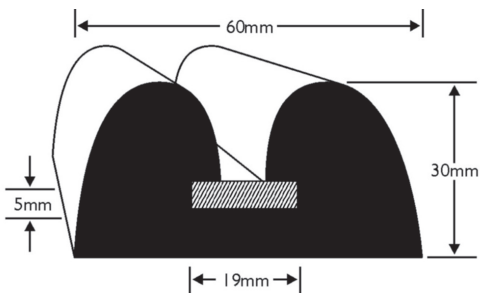

PVC 883

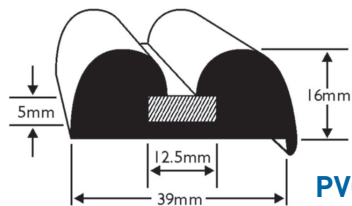

PVC 624

Flexible PVC profiles

Product samples are available upon request either through our website or sales office. To view our full range and to download our brochures visit www.wilks.co.uk/media.html

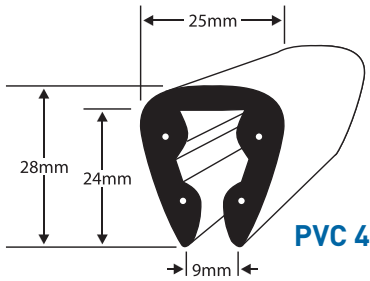

PVC 4

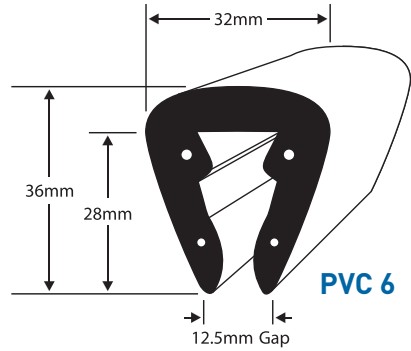

PVC 6

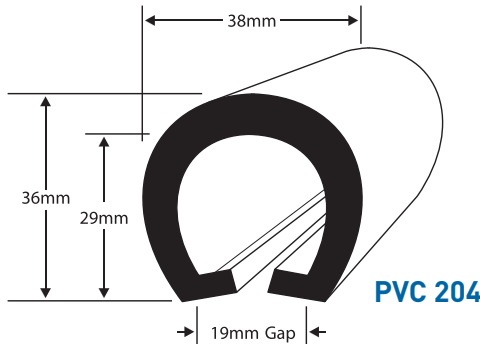

PVC 204

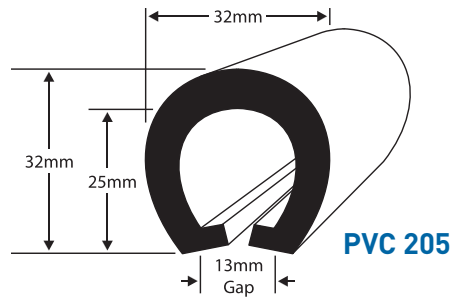

PVC 205

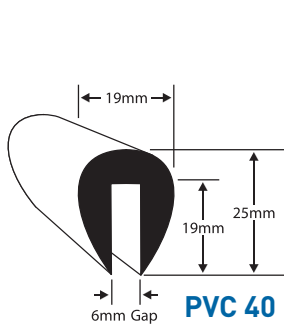

PVC 40

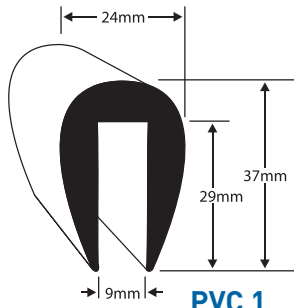

PVC 1

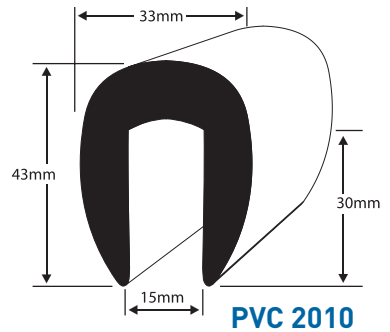

PVC 1010

Rigid PVC with Insert

To view our full range and to download our brochures visit www.wilks.co.uk/media.html

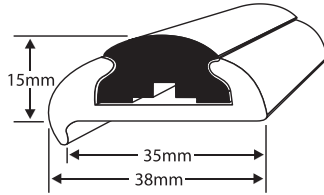

PVC 1472R

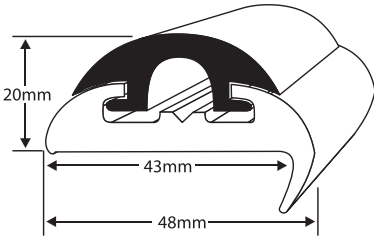

PVC 1417R

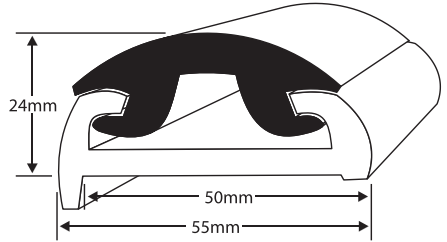

PVC 1613R

Also available with a larger insert.
Contact Sales for details.

Flexible PVC with Insert

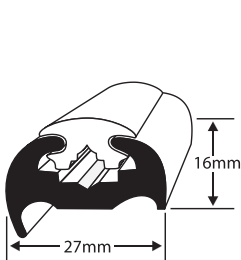

PVC 180

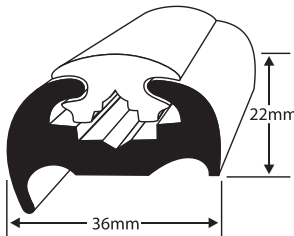

PVC 370

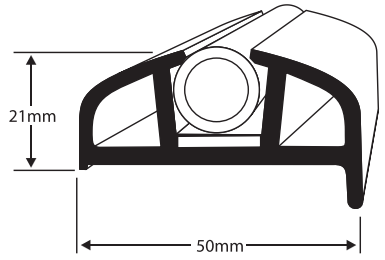

PVC 168

For details of our complete range please visit www.wilks.co.uk



Rigid PVC with Stainless Steel Insert

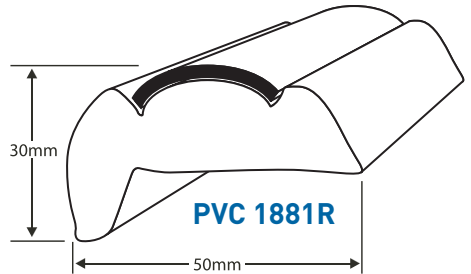

Aluminium with PVC Insert

Product samples are available upon request either through our website or sales office. Our aluminium is supplied polished and anodised as standard.

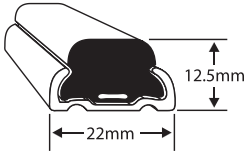

ALI 5222
(anodised only)

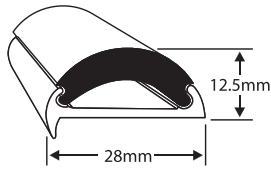

ALI 114
(anodised only)

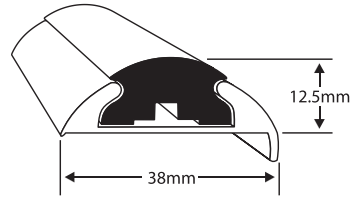

ALI 68
(anodised only)

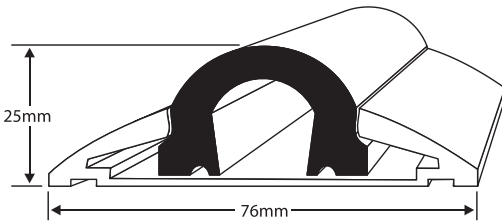

ALI 607

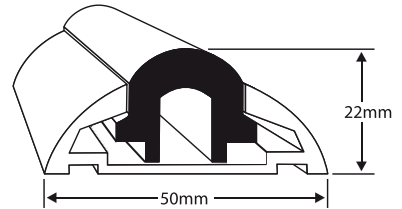

ALI 604

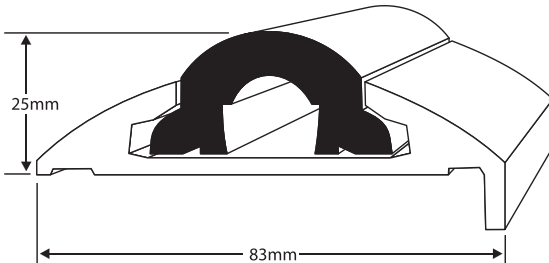

ALI 585

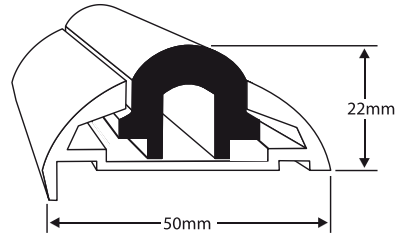

ALI 605

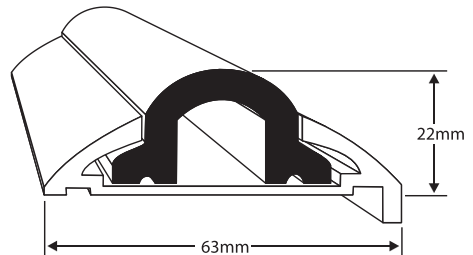

ALI 606

For details of our complete range please visit www.wilks.co.uk



traditional range and Flexiteek trims

Toe Rails

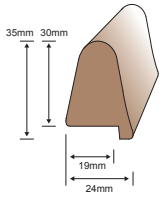

PVC 2716

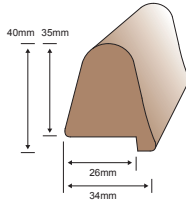

PVC 2625

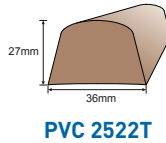

PVC 2522T

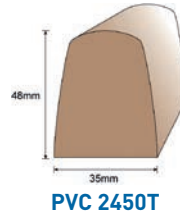

PVC 2450T

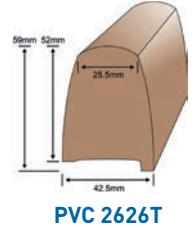

PVC 2626T

Top Cappings

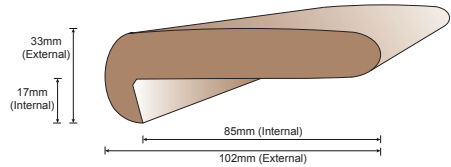

PVC 2455T

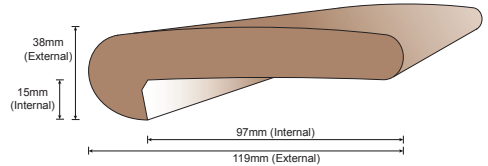

PVC 2441T

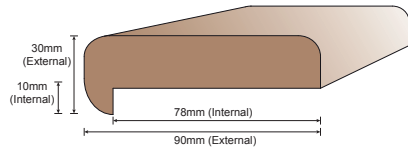

PVC 2717



10mm Plugging

Fendering

Supplied in "factory finish" ready for sanding. Any of our flexible fendering profiles can be produced in our Traditional finish, please enquire for minimum order quantities.

BUMP! 65

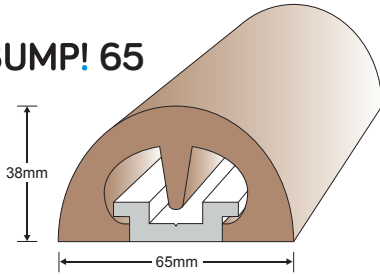

BUMP! 53

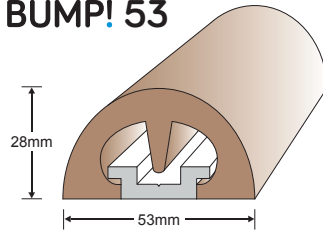

Block Profiles

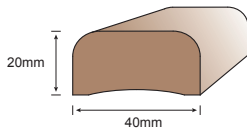

PVC 2624 Nosing

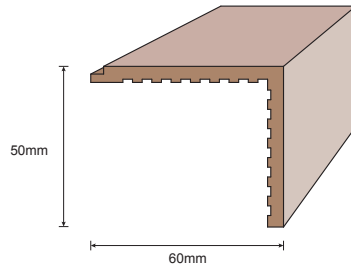

PVC 2719 Angle

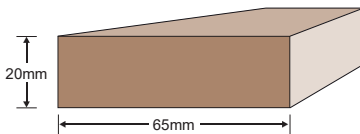

PVC 2584

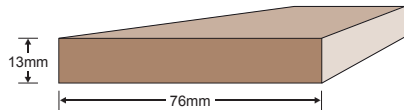

PVC 2521

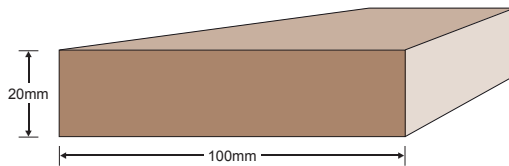

PVC 2562



COOLER
LIGHTER
BETTER

FLEXITEEK 2G™

FLEXITEEK

THE NEXT GENERATION

www.flexiteek.com